

Dimensions of the Pyramid

Exterior Dimensions of the Great Pyramid

Pyr. ins.

Vertical height of apex above mean Socket level	-	5813.0101343+
Base-side length, between corner Sockets	-	9131.0549666+
Diagonal length of base, between corner Sockets	-	12913.2617725+
Diagonal length of base, at Platform level	-	12847.1764521+

Dimensions of the King's Chamber

Breadth, north to south walls	-	-	-	206.0658439+
Length (double the breadth)	-	-	-	412.1316879+
Height, first, i.e., floor to ceiling	-	-	-	230.3886174+
Height, second, i.e., the granite walls alone	-	-	-	235.2432470+
Diagonal of end walls	-	-	-	309.0987659+
Diagonal of side walls	-	-	-	472.1561640+
Diagonal of floor (double the first height)	-	-	-	460.7772349+
Cubic Diagonal	-	-	-	515.1646099+

Dimensions of the Ante-Chamber

Length, north to south walls	-	-	-	116.2602026+
Length of granite portion of the floor	-	-	-	103.0329219+
Breadth between granite wainscots	-	-	-	41.2131687+
Breadth between east and west walls above wainscots	-	-	-	65.1704255+
Height, floor to ceiling	-	-	-	149.4406510+
Height of east wainscot above floor	-	-	-	103.0329219+
Height of west wainscot above floor	-	-	-	111.8033988+

Dimensions of the Queen's Chamber

(According to the measurements of Professor W. M. Flinders Petrie*)

Length, east to west walls	-	-	-	226.1735819+
Breadth, north to south walls	-	-	-	205.6123472+
Height, north and south walls	-	-	-	184.2851046+
Height, to gable ridge line of roof	-	-	-	245.0186692+

*NOTE—Professor C. Piazzi Smyth did not measure in the Queen's Chamber so accurately as Professor Petrie.

Passages of the Pyramid

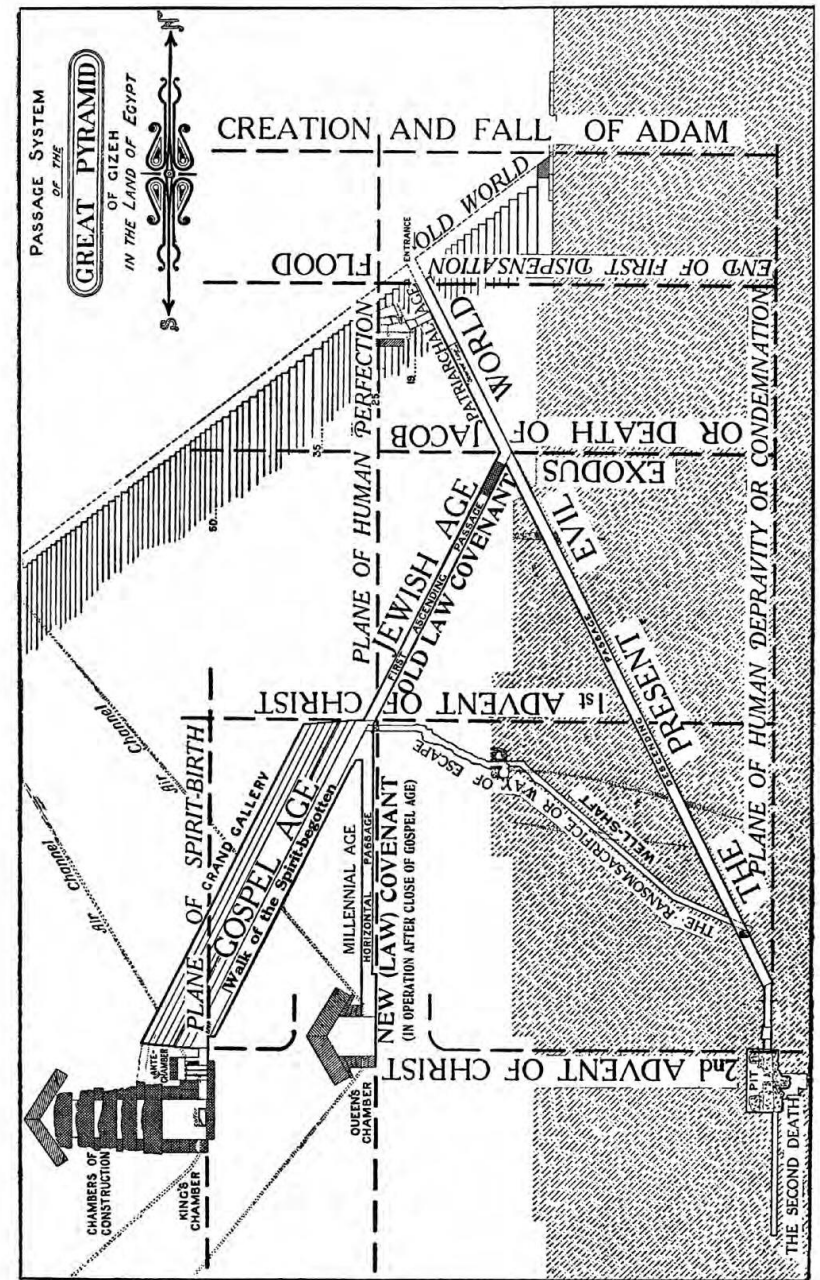

Date of our Lord's Birth and Death

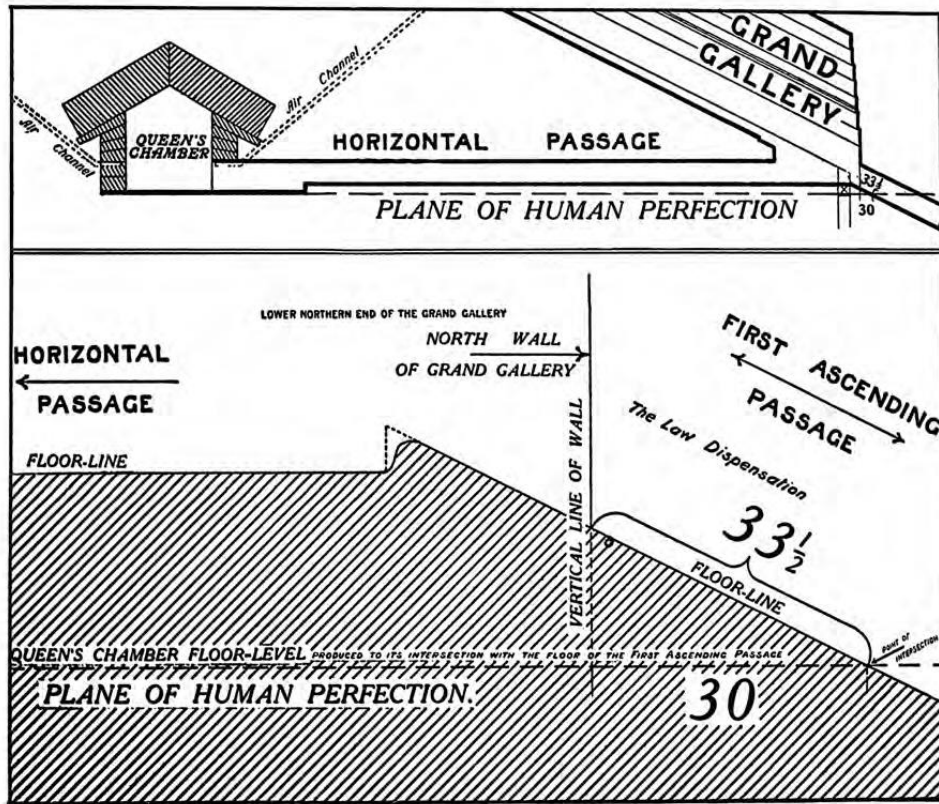

Date of the Building of the Pyramid

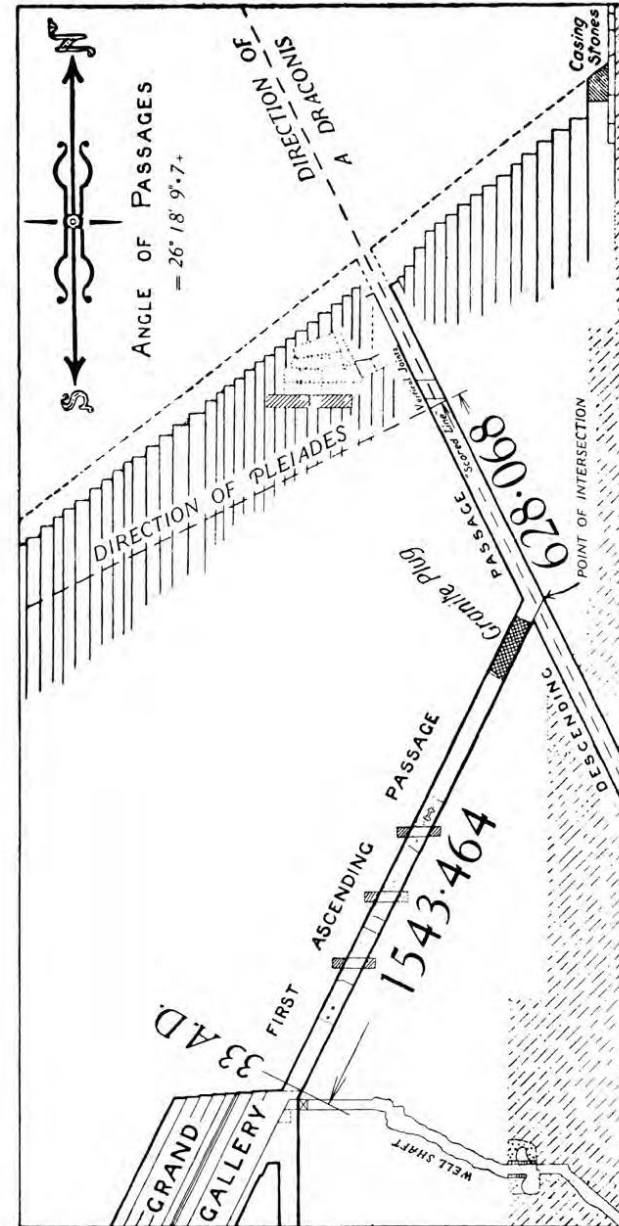

The First Dispensation

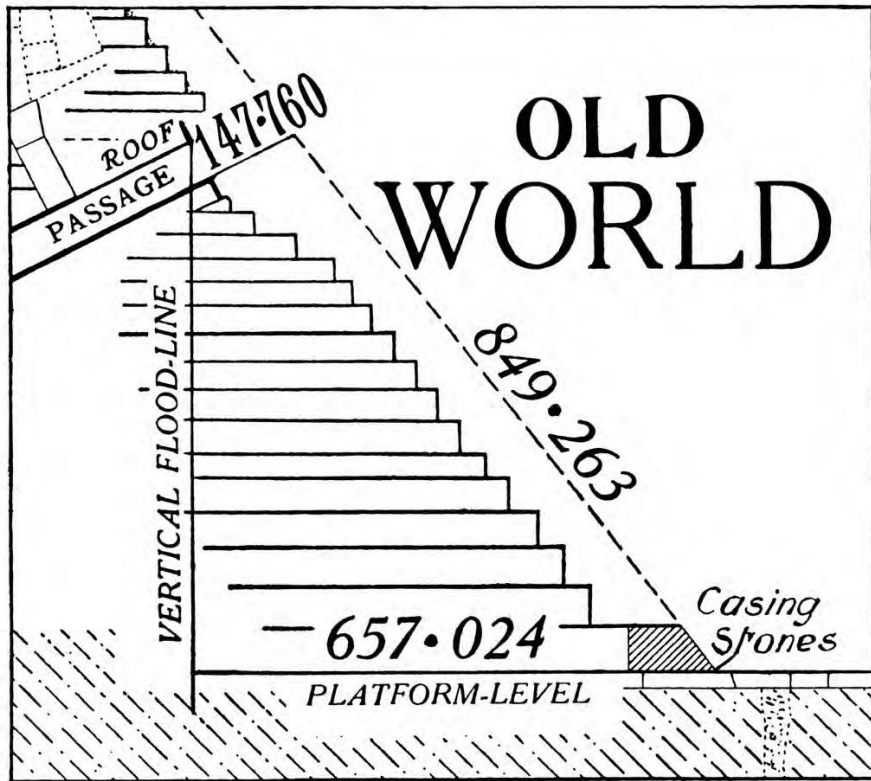

The Separation of Israel from the World

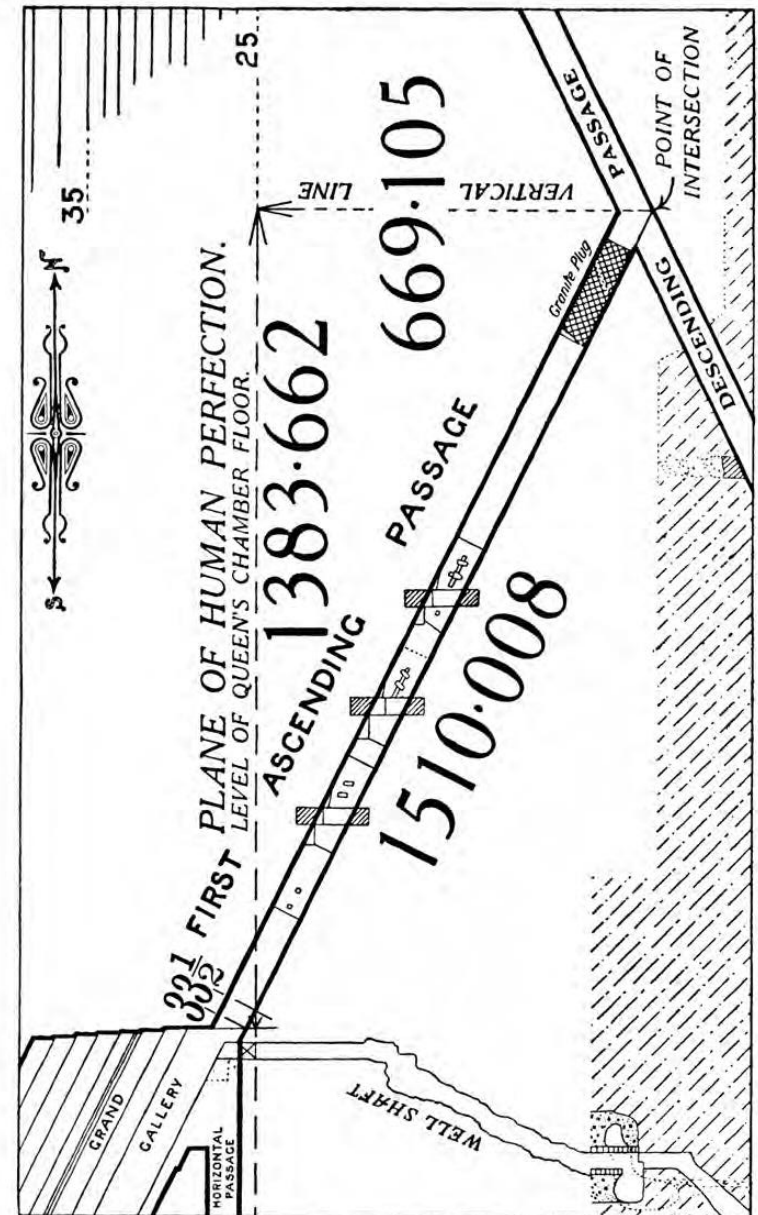

The Well Shaft

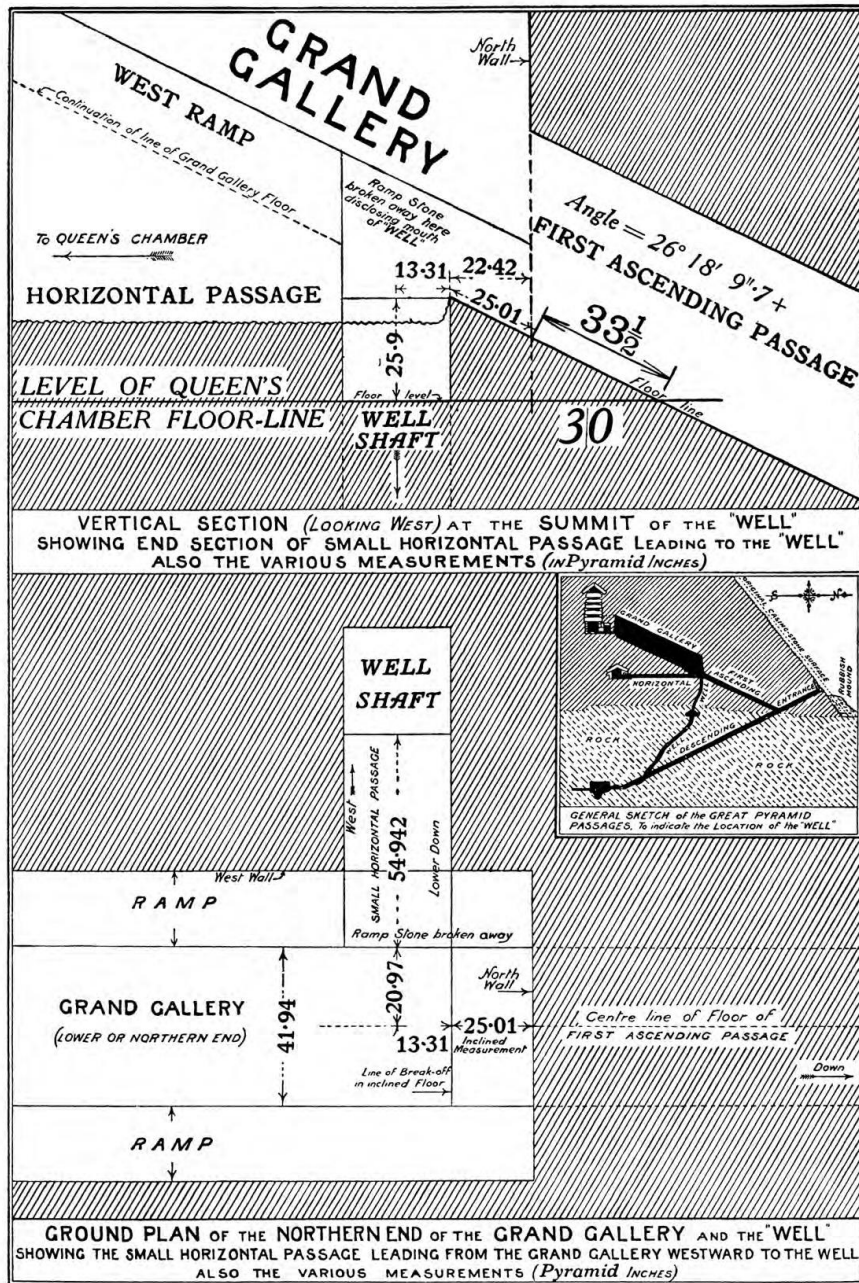

206

The Well Shaft Cross Section

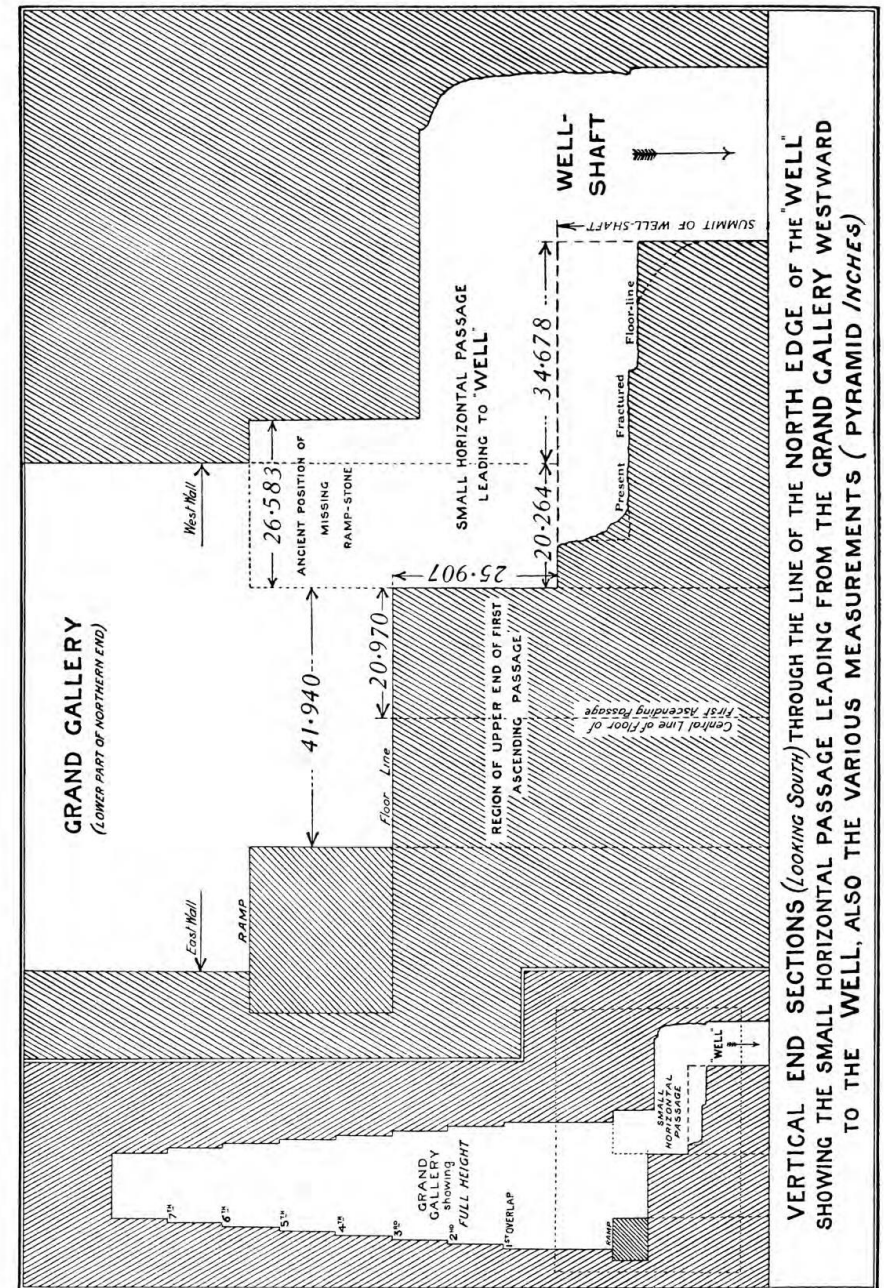

207

The Kingdom of Israel from Canaan to Gentile Times

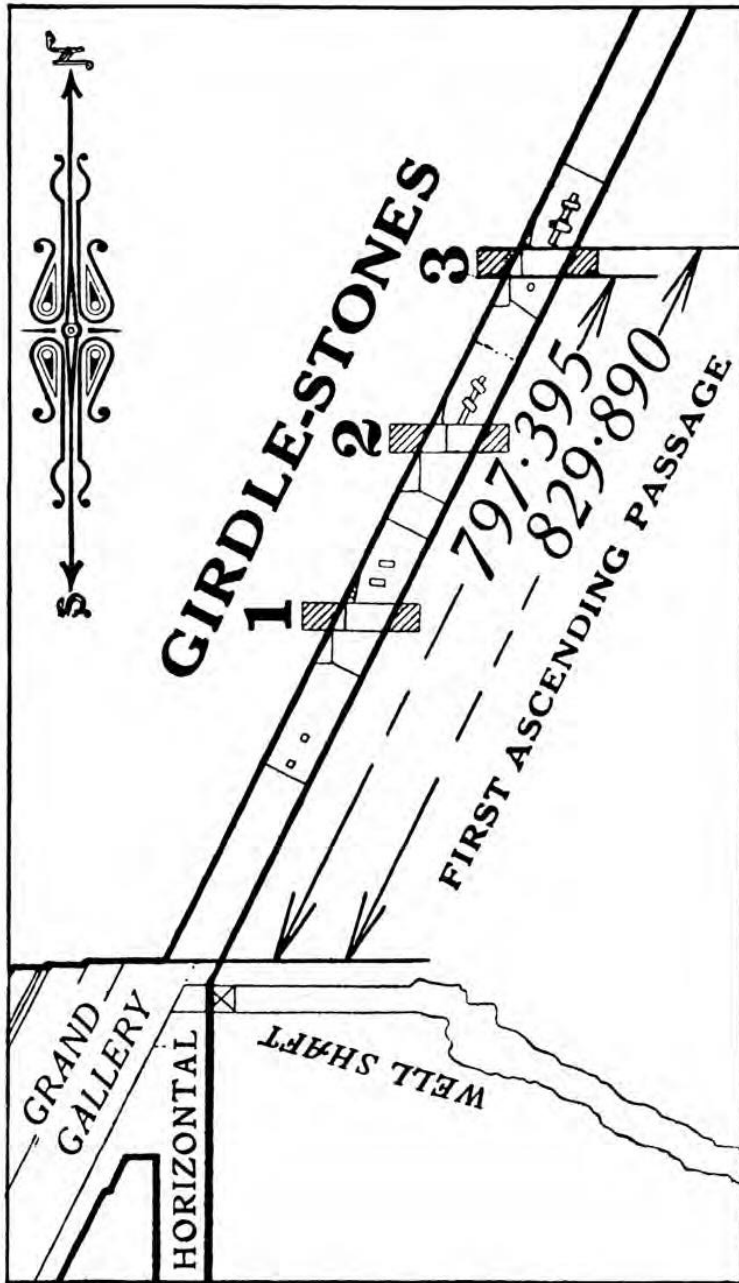

The Gospel Age and Seven Times of Gentiles

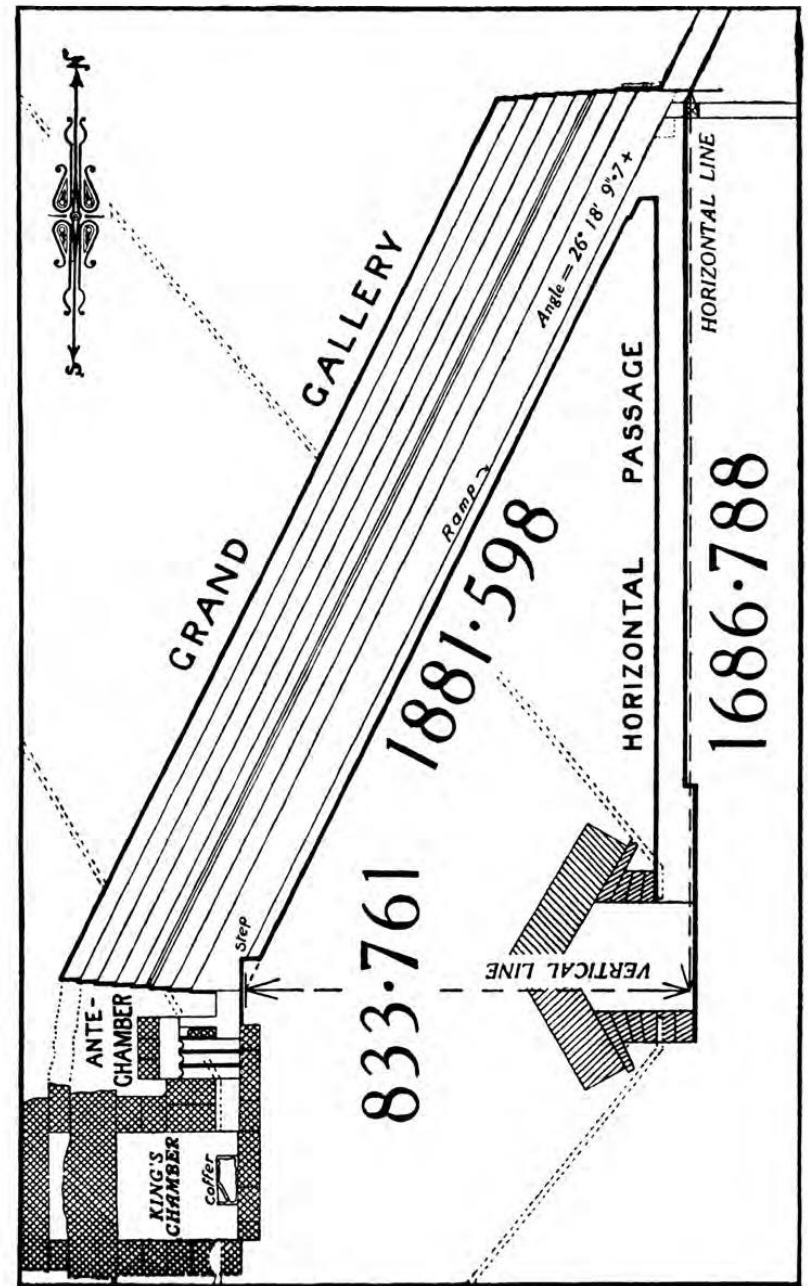

End of Harvest of Second Dispensation

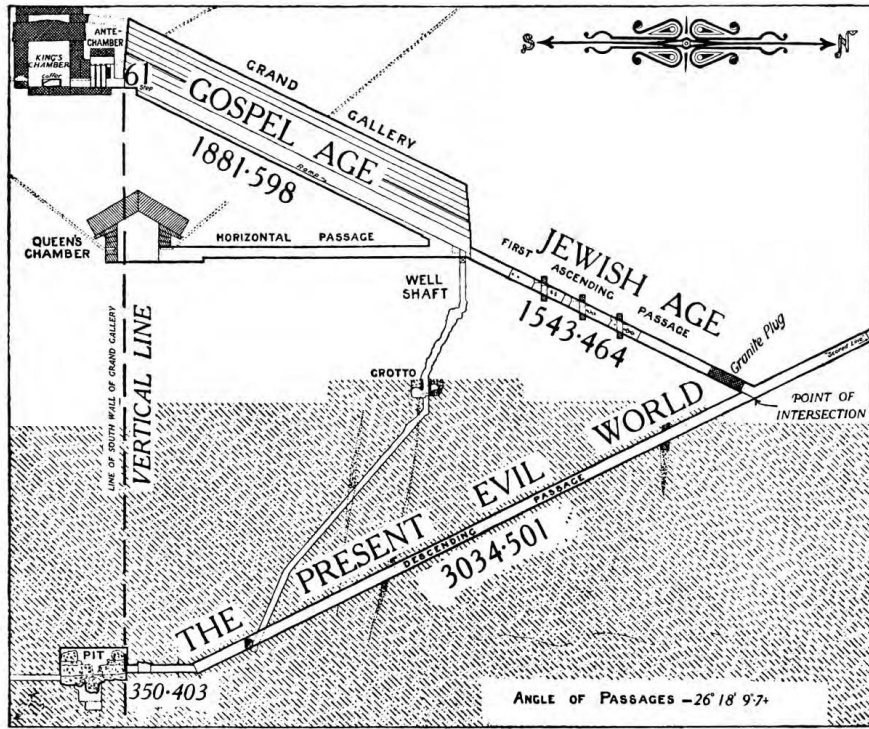

168

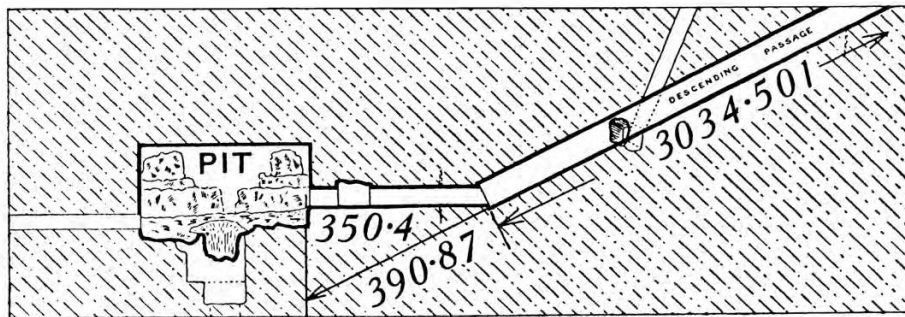

165

End of the Little Season

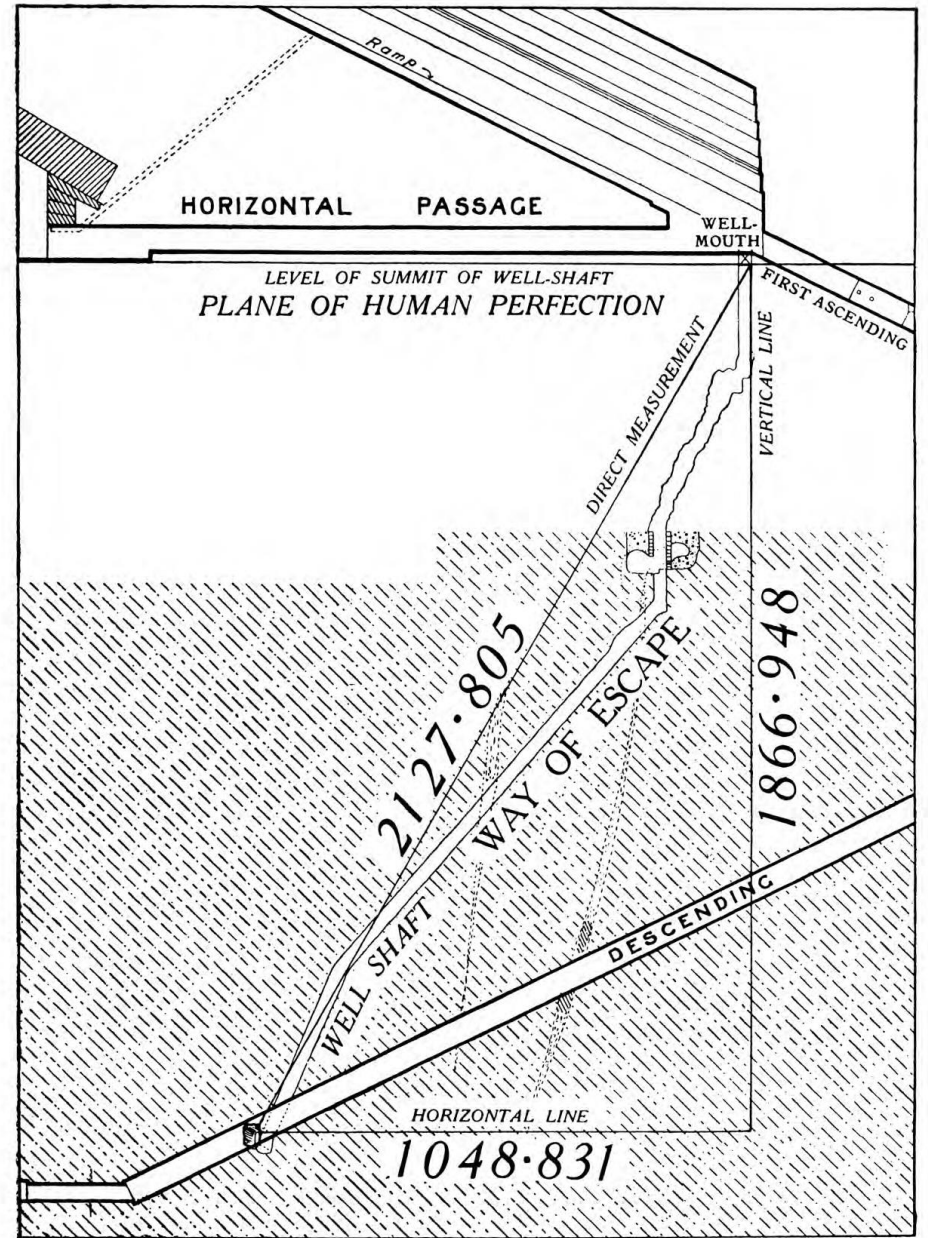

152